

**NOTICE OF MEETING  
CITY OF SOUTH PADRE ISLAND  
PARKS & KEEP SPI BEAUTIFUL COMMITTEE**

**NOTE: One or more members of the City of South Padre Island City Council may attend this meeting; if so, this statement satisfies the requirements of the OPEN MEETINGS ACT.**

NOTICE IS HEREBY GIVEN THAT THE PARKS & KEEP SPI BEAUTIFUL COMMITTEE OF THE CITY OF SOUTH PADRE ISLAND, TEXAS, WILL HOLD A REGULAR MEETING ON:

**WEDNESDAY, APRIL 18, 2018  
9:00 A.M. AT THE MUNICIPAL BUILDING,  
CITY COUNCIL CHAMBERS, 2<sup>ND</sup> FLOOR  
4601 PADRE BOULEVARD, SOUTH PADRE ISLAND, TEXAS**

- 1. Call to Order.
- 2. Pledge of Allegiance.
- 3. Public Comments and Announcements: *This is an opportunity for citizens to speak to Committee relating to agenda or non-agenda items. Speakers are required to address Committee at the podium and give their name before addressing their concerns. [Note: State law will not permit the Parks & Keep SPI Beautiful Committee to discuss debate or consider items that are not on the agenda. Citizen Comments may be referred to City Staff or may be placed on the agenda of a future Parks & Keep SPI Beautiful Committee meeting]*
- 4. Approval of March 28, 2018 special meeting minutes.
- 5. Update on Skate Park and EDC Funds.
- 6. Discussion and possible action regarding the Dog Park.
- 7. Discussion and possible action to pick a date for a bay cleanup. *(Erica Underwood)*
- 8. Update, discussion regarding City Parks maintenance.
- 9. Update on the Parks Master Plan.
- 10. Agenda items for May 16, 2018 regular Meeting.
- 11. Adjournment.

DATED THIS THE 13<sup>TH</sup> DAY OF APRIL 2018

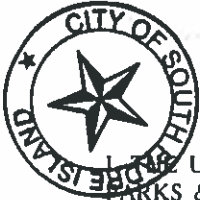

  
\_\_\_\_\_  
Susan Hill, City Secretary

THE UNDERSIGNED AUTHORITY, DO HEREBY CERTIFIED THAT THE ABOVE NOTICE OF MEETING OF THE PARKS & KEEP SPI BEAUTIFUL COMMITTEE OF THE CITY OF SOUTH PADRE ISLAND, TEXAS IS A TRUE AND CORRENT COPY OF SAID NOTICE AND THAT I POSTED A TRUE AND CORRECT COPY OF SAID NOTICE ON THE BULLETIN BOARD AT CITY HALL/MUNICIPAL BUILDING ON APRIL 13, 2018 AT/OR BEFORE 5:00 P.M. AND REMAINED SO POSTED CONTINUOUSLY FOR AT LEAST 72 HOURS PRECEDING THE SCHEDULED TIME OF SAID MEETING.

  
\_\_\_\_\_  
Susan Hill, City Secretary

THIS FACILITY IS WHEELCHAIR ACCESSIBLE, AND ACCESSIBLE PARKING SPACES ARE AVAILABLE. REQUESTS FOR ACCOMMODATIONS OR INTERPRETIVE SERVICES MUST BE MADE 48 HOURS PRIOR TO THIS MEETING. PLEASE CONTACT BUILDING OFFICIAL, DAVID TRAVIS; ADA DESIGNATED RESPONSIBLE PARTY AT (956)761-8103.

**SPECIAL MEETING MINUTES  
CITY OF SOUTH PADRE ISLAND  
PARKS & KEEP SPI BEAUTIFUL COMMITTEE**

**Wednesday, March 28, 2018**

**I. Call to order.**

The Parks & Keep SPI Beautiful Committee Members of the City of South Padre Island, Texas held a Regular Meeting on Wednesday, March 28, 2018 at the Municipal Complex Building, 2<sup>nd</sup> Floor, 4601 Padre Boulevard, South Padre Island, Texas. Chairman Debbie Huffman called the meeting to order at 1:00 p.m. A quorum was present: Committee Members Pat Rasmussen, Carol Bolstad, and Erica Underwood. Member absent were Sally Scaman, Kat Lillie, and Javier Gonzalez.

City staff members present were: City Manager Susan Guthrie, Assistant City Manager Darla Jones, Public Works Director Alex Sanchez, Assistant Public Works Director Jon Wilson, Environmental Health Director Victor Baldovinos, Administrative Assistant Angela Cantu, Planning Director Clifford Cross, and Administrative Assistant Marta Martinez. Also present was Mayor Dennis Stahl.

**II. Pledge of Allegiance.**

**III. Public Comments and Announcements**

Public comments and announcements were given at this time.

**IV. Discussion & action to approve meeting minutes from February 21, 2018.**

Motion to approve was made by Carol Bolstad, second by Pat Rasmussen. Motion passed unanimously.

**V. Drawing for two-year staggered terms for newly created committee.**

Terms to expire on 2018 are: Debbie Huffman, Erica Underwood, and Javier Gonzalez. Terms to expire on 2019 are: Carol Bolstad, Pat Rasmussen, Sally Scaman, and Kat Lillie.

**VI. Discussion and action regarding recommendation to the City Council for the award of contract for construction of the Skate Park at John L. Tompkins Park.**

Clifford Cross gave a presentation regarding the Skate Park. Staff presented five options to the Committee:

- 1) Request the additional funds needed from excess reserves through the City Council
- 2) Re-bid the project
- 3) Incorporate the skate park into the grant for Phase 2 of Tompkins Park
- 4) Fundraising
- 5) Scrap the project and request the EDC allow a reallocation of funds

After some discussion motion to reject the bid proposals received was made by Debbie Huffman, second by Carol Bolstad. Motion carried unanimously.

**VII. Update on inventory and maintenance of parks.**

Update on inventory and maintenance of parks was given by Clifford Cross. No action was taken.

**VIII. Update on Tompkins Park Phase 2:**

- ~Texas Parks & Wildlife Grant – due date, prerequisites
- ~Skate Park Fundraising – subcommittee recommendations, brochure

Update on Tompkins Park Phase 2 was given by Clifford Cross. No action was taken.

**IX. Parks Plan Update including appointment of a subcommittee.**

Parks Plan Update including appointment of a subcommittee was given by Clifford Cross. No action was taken.

**X. Update of upcoming events sponsored by the Parks and Keep SPI Beautiful Committee and action to create additional events.**

Update on upcoming events was given by Clifford Cross. No action was taken.

**XI. Discussion and action on possible Dog Park.**

Clifford Cross gave a presentation regarding the Dog Park. Motion to move forward with Dog Park and have staff bring back for further discussion at next meeting was made by Debbie Huffman, seconded by Carol Bolstad. Motion carried unanimously.

**XII. Update on status of AT&T property next to Water Tower Park on West Huisache.**

Discussed under item XI. .

**XIII. Update on Vans Donation application.**

Update on Vans Donation application was given by Clifford Cross. No action was taken.

There being no further business, Ms. Huffman adjourned the meeting at 1:58 p.m.

---

Debbie Huffman, Chairman

---

Marta Martinez, Secretary





SOUTH PADRE ISLAND SKATEPARK #6623

SOUTH PADRE ISLAND, TX



20 YEAR WARRANTY

FASTENER FREE RIDING SURFACE



MAXGRIP™ POLYESTER POWDERCOAT 3/16" STEEL RIDING SURFACE

WWW.AMERICANRAMPCOMPANY.COM

*This page is the creative property of American Ramp Company. It cannot be copied or redistributed.*



WWW.AMERICANRAMPCOMPANY.COM

601 McKinley  
 Joplin, MO 64801  
 Tel: (417) 206-6816  
 Toll Free: (800) 949-2024  
 Fax: (417) 206-6888

[sales@americanrampcompany.com](mailto:sales@americanrampcompany.com)

**DRAWN BY** Chuck Dodge

**DATE** 4/11/18

**REP. AGENCY**

**American Ramp Company**

**REP. NAME**

**Jeremy Jones**

**REP. PHONE**

**(417) 438-9513**



CUSTOMER APPROVAL	DATE

**PARK ENCLOSED?** Yes

**PRO SERIES** ✓

**X SERIES** -

**STEALTH SERIES** -

**STEALTH CLASSIC SERIES** -

**PROJECT NAME**

**South Padre Island Skate Park**

**DESIGN NO.** 6623

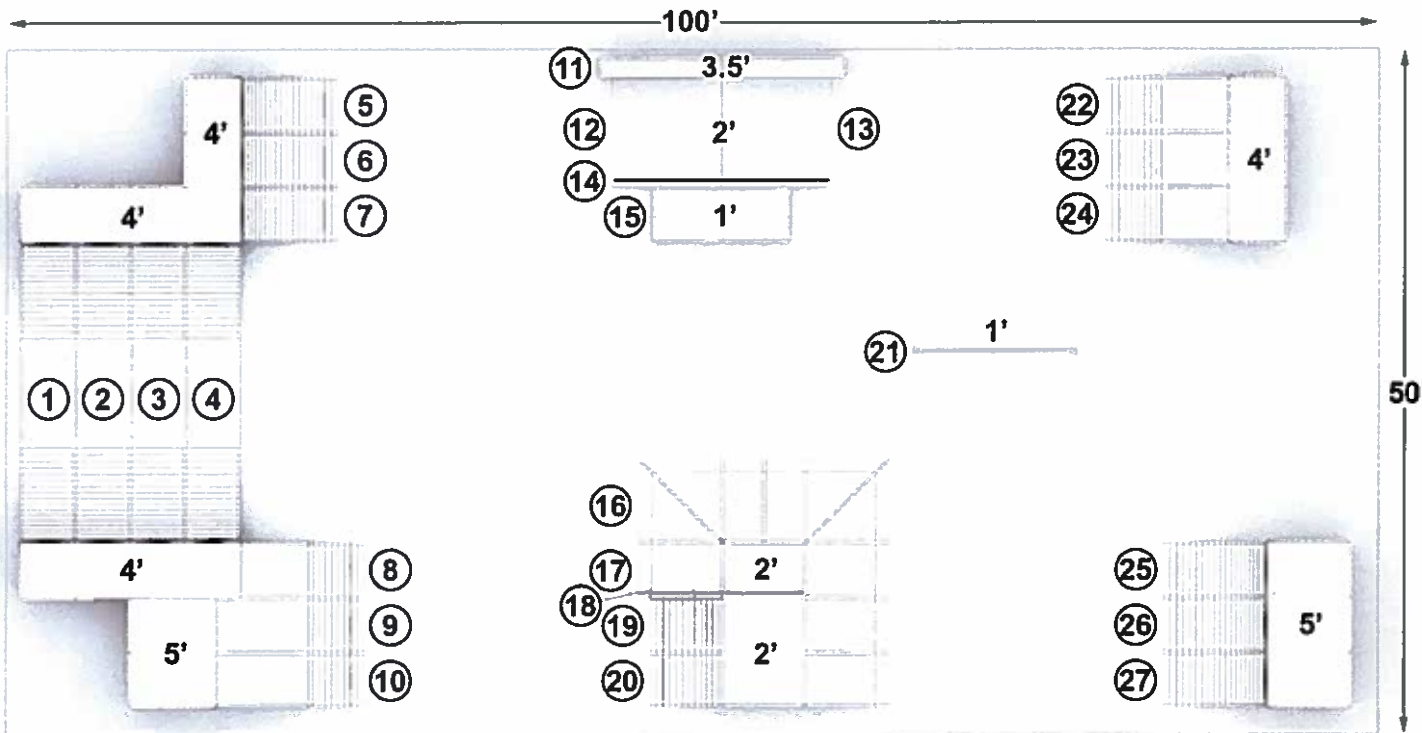

[CLICK HERE TO VIEW DESIGN RENDERINGS](#)

601 McKinley  
 Joplin, MO 64801  
 Toll-free 877-RAMP-778  
 Local 417-206-6816  
 Fax 417-206-6888  
[sales@americanrampcompany.com](mailto:sales@americanrampcompany.com)



Quote #	Design #	FOB
Q22227	6623	South Padre Island, TX

Item	Obstacle	Height	Width	Length
1	Half Pipe	4.0'	4.0'	30.0'
2	Half Pipe	4.0'	4.0'	30.0'
3	Half Pipe	4.0'	4.0'	30.0'
4	Half Pipe	4.0'	4.0'	30.0'
5	Quarter Pipe	4.0'	4.0'	11.0'
6	Quarter Pipe	4.0'	4.0'	11.0'
7	Quarter Pipe	4.0'	4.0'	7.0'
8	Bank Ramp	4.0'	4.0'	9.0'
9	Bank Ramp	5.0'	4.0'	17.0'
10	Bank Ramp	5.0'	4.0'	17.0'
11	Hubba Ledge (Replica Series)	3.5'	1.5'	18.0'
12	Bank Ramp (Wedge)	2.0'	8.0'	8.0'
13	Bank Ramp (Wedge)	2.0'	8.0'	8.0'
14	Grind Rail, Kinked (Round)	1.5'	2"	16.0'
15	Grindbox	1.0'	4.0'	10.0'
16	Pyramid Section (Wedge)	2.0'	6.0'	18.0'
17	Wedge, Flat, Wedge	2.0'	4.0'	18.0'
18	Grind Rail, Kinked (Round)	1.5'	2"	12.0'
19	Jump Box	2.0'	4.0'	17.0'
20	Jump Box	2.0'	4.0'	17.0'
21	Grind Rail (Round)	1.0'	2"	12.0'
22	Bank Ramp	4.0'	4.0'	13.0'
23	Bank Ramp	4.0'	4.0'	13.0'
24	Bank Ramp	4.0'	4.0'	13.0'
25	Quarter Pipe	5.0'	4.0'	14.0'
26	Quarter Pipe	5.0'	4.0'	14.0'
27	Quarter Pipe	5.0'	4.0'	14.0'

Subtotal	\$108,370.05
Framework Enclosures	\$10,837.01
Freight	FREE through BuyBoard
Supervised Installation	\$5,418.50
<b>TOTAL</b>	<b>\$124,625.56</b>

**Notes:**

- Framework enclosures are optional.
- If your project is subject to prevailing wage, bonding requirements, or sales tax, call for revised quote.



**Purchase through our competitively bid BuyBoard contract—all BuyBoard orders include free freight!**

**WE LOOK FORWARD TO BUILDING YOU A GREAT SKATE PARK!**

*This page is the creative property of American Ramp Company. It cannot be copied or redistributed.*





**AMERISTAR FENCE PRODUCTS**  
**ECHELON PLUS® - Aluminum Ornamental Fence System – Internally Secured**  
**Construction Specification - SECTION 32 31 00**

**PART 1 - GENERAL**

**1.01 WORK INCLUDED**

The contractor shall provide all labor, materials and all necessary items for the installation of the Echelon Plus® Puppy Panel ornamental aluminum fence system defined herein at (specify project site).

**1.02 RELATED WORK**

Section \_\_\_ - Earthwork

Section \_\_\_ - Concrete

**1.03 SYSTEM DESCRIPTION**

The manufacturer shall supply a total ornamental aluminum fencing system of the Ameristar Echelon Plus® Puppy Panel Majestic design. The system shall include all components (i.e., pickets, posts, rails, gates and hardware) required.

**1.04 QUALITY ASSURANCE**

The contractor shall provide laborers and supervisors who are thoroughly familiar with the type of construction involved and the materials specified.

**1.05 REFERENCES**

- ASTM B117 - Practice for Operating Salt-Spray (Fog) Apparatus.
- ASTM B221 - Standard Specification for Aluminum and Aluminum-Alloy Extruded Bars, Rods, Wire, Profiles and Tubes.
- ASTM D523 - Test Method for Specular Gloss.
- ASTM D822 - Practice for Conducting Tests on Paint and Related Coatings and Materials using Filtered Open-Flame Carbon-Arc Light and Water Exposure Apparatus.
- ASTM D1654 - Test Method for Evaluation of Painted or Coated Specimens Subjected to Corrosive Environments.
- ASTM D2244 - Test Method for Calculation of Color Differences from Instrumentally Measured Color Coordinates.
- ASTM D2794 - Test Method for Resistance of Organic Coatings to the Effects of Rapid Deformation (Impact).
- ASTM D3359 - Test Method for Measuring Adhesion by Tape Test.

**1.06 SUBMITTAL**

The manufacturer's submittal package shall be submitted prior to installation to confirm compliance with all requirements for materials specified in this section.

**1.07 PRODUCT HANDLING AND STORAGE**

Upon receipt at the job site, all materials shall be checked to ensure that no damages occurred during shipping or handling. Materials shall be stored in such a manner to ensure proper ventilation and drainage and to protect against damage, weather, vandalism and theft.

**PART 2 - MATERIALS**

**2.01 MANUFACTURER**

The ornamental fence system shall conform to Ameristar's Echelon Plus Puppy Panel aluminum ornamental fencing, Majestic (specify 3-rail, 4-rail) style manufactured by Ameristar Fence Products, Inc. in Tulsa, Oklahoma. Contact Matt Bean for additional information 888.333.3422.

**2.02 MATERIAL**

**A.** Aluminum material for fence framework (i.e., tubular pickets, rails and posts) shall conform to the requirements of ASTM B221. The aluminum extrusions for posts and rails shall be Alloy and Temper Designation 6005-T5. The aluminum extrusions for pickets shall be Alloy and Temper Designation 6063-T5.

**B.** Pickets shall be 3/4" square x .045" thick. Horizontal rails shall be 1-1/4" x 1-7/16" Forerunner™ channel with .060" thick top & internal web wall, and .090" thick side walls and shall be punched to allow picket to pass through the top of the rail. The Forerunner™ rail shall be constructed with an internal web insert providing a raceway for the pickets to be retained with a 1/8" retaining rod. The number of rails shall vary with the style, height and strength as determined by manufacturer. Fence posts and gate posts shall meet the minimum size requirements of Table 1.

**AMERISTAR® ECHELON PLUS™  
LIMITED LIFETIME WARRANTY**

AMERISTAR® Echelon Plus™ Ornamental Aluminum Fencing System is manufactured from the highest quality materials by skilled craftsmen to meet the highest standards of workmanship in the industry. Extruded aluminum framework shall be subject to a six stage pretreatment/wash followed by an electrostatic spray application of a "no-mar" TGIC polyester powder coat finish, which provides the protection necessary to withstand adverse environmental conditions.

The powder coated surface on all aluminum framework (i.e., pickets, rails and posts) by AMERISTAR® is guaranteed under normal and proper usage, against cracking, peeling, chipping, blistering or corroding. Normal and proper usage does not include physical damage or abrasion to the protective coating.

AMERISTAR® Echelon Plus™ Ornamental Aluminum Fencing System framework is also guaranteed for the same period of time against defects in workmanship or materials.

Should any ornamental aluminum fence framework manufactured by Ameristar® Fence Products fail in accordance with any of the above conditions, Ameristar® Fence Products warrants to the original purchaser their redemption through replacement or renewal. The decision as to which method of redemption is allowed is solely at the discretion of Ameristar. Notice of failure under the conditions of this warranty shall be sent to Ameristar® Fence Products or its authorized representative, in writing, together with proof of purchase and shall specify the nature of the defect and when it was first observed. Should the fence be improperly installed, Ameristar® Fence Products shall not be responsible for guaranteed performance or appearance of the material. Neither does this guarantee apply when failure or damage is due to improper use or application, abuse or misuse, vandalism or acts of God. Ameristar® Fence Products reserves the right to inspect the material to determine validity of the claim.

Upon validation of the claim by Ameristar® Fence Products or its authorized representative, redemption by replacement or renewal shall be made by Ameristar® Fence Products. Reimbursement for the costs of removal and installation of materials are not included in the guarantee, nor will Ameristar® Fence Products provide those services.

The above constitutes the complete warranty by the manufacturer. No other agreement, written or implied, is valid. Ameristar® Fence Products does not authorize any other person or agent to make any other express warranties. Ameristar® Fence Products neither assumes nor authorizes any other person or agent to assume any other liability in connection with AMERISTAR® Echelon Plus™ Ornamental Aluminum Fencing System. Some jurisdictions do not allow limitations on how long an implied warranty lasts, nor do they allow an exclusion or limitation of incidental or consequential damages; therefore, the limitations and exclusions noted herein may not apply.

PURCHASE DATE \_\_\_\_\_

DEALER SIGNATURE \_\_\_\_\_



**AMERISTAR®**

P. O. BOX 581000 TULSA, OKLAHOMA 74158-1000

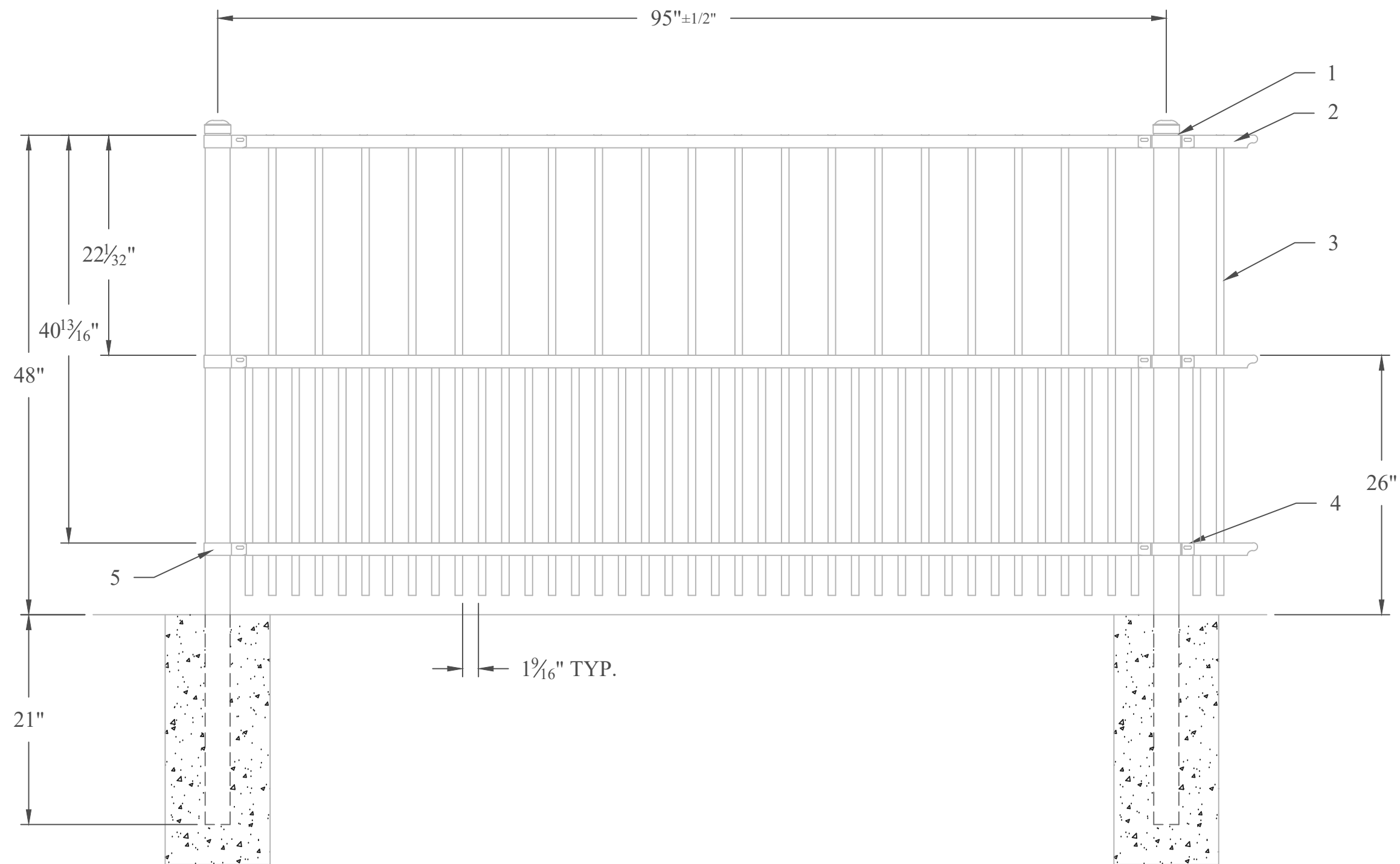

#	DESCRIPTION
1	2 1/2" Sq. POST
2	1 1/16" x 1 1/4" FORERUNNER RAIL
3	3/4" Sq. PICKET
4	BRACKET ABX3
5	BRACKET ABX4

PROPRIETARY INFORMATION					 1555 N. Mingo Tulsa, OK 74116 1-888-333-3422 www.ameristarfence.com		
This drawing is the proprietary property of AMERISTAR, Tulsa, OK and must not be duplicated or used in whole or in part for the making of drawings, prints or parts to the detriment of, or harm to, the owner. In accepting this drawing, the recipient agrees to keep the information contained confidential.					TITLE: ECHELON PLUS PUPPY PANEL MAJESTIC 3R EXT 4'T 8"W		
REV	BY	CK'D	DATE	DESCRIPTION	DATE: 10/27/14	SCALE: Do Not Scale	SHEET: 1/3
A	CI		11-25-08	INITIAL RELEASE			
B	LJM	0113-81	10-27-14	PKT SPACING WAS 1 3/8"	DRN BY: LJM	CHK BY:	REV: B
					DRAWING NO: AMX3488D		

# Echelon Plus<sup>®</sup>



[AMERISTARFENCE.COM](http://AMERISTARFENCE.COM) | 888-333-3422

ASSA ABLOY, the global leader in door opening solutions

**AMERISTAR<sup>®</sup>**

**ASSA ABLOY**

# Echelon Plus<sup>®</sup>

.75"sq x .045" wall PICKETS | 1.4375" x 1.25" x (.090" side / .060" top) ForeRunner™ RAILS  
2.5"sq x .060" POSTS w/reinforced internal web



***Echelon Plus has taken the quality and performance of aluminum ornamental fencing to a higher level.***

Today, the damage potential that threatens fences has increased significantly in probability and destructive force. Echelon Plus is ***designed with the long-term durability to withstand rigorous environments.***

The cross-section of the Echelon Plus rail is reinforced with an ***internal web*** that significantly increases strength, particularly against ***forces acting horizontally.*** This added strength, coupled with an improved post design, powder-coated finish, and fully welded gates, ***guarantees years of maintenance-free service and value.***

## THE ECHELON PLUS DIFFERENCE

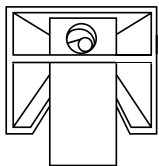

### **Echelon ForeRunner<sup>®</sup>** ***Internal Locking System***

- ▶ Internal rod is tamper proof and pickets cannot be removed
- ▶ Retainer rod is hidden and rail has a “good neighbor” appearance
- ▶ Retainer goes through two walls of picket, yielding twice the support

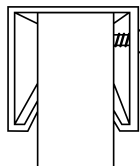

### **Competitors U-Channel** ***Removable Tek Screws***

- ▶ Picket attachment can easily be compromised with simple tools
- ▶ Exposed Tek screw detracts from a smooth architectural profile
- ▶ Tip of Tek screw barely engages one wall of picket

# NO RIVETS. NO SCREWS. NO WELDS.

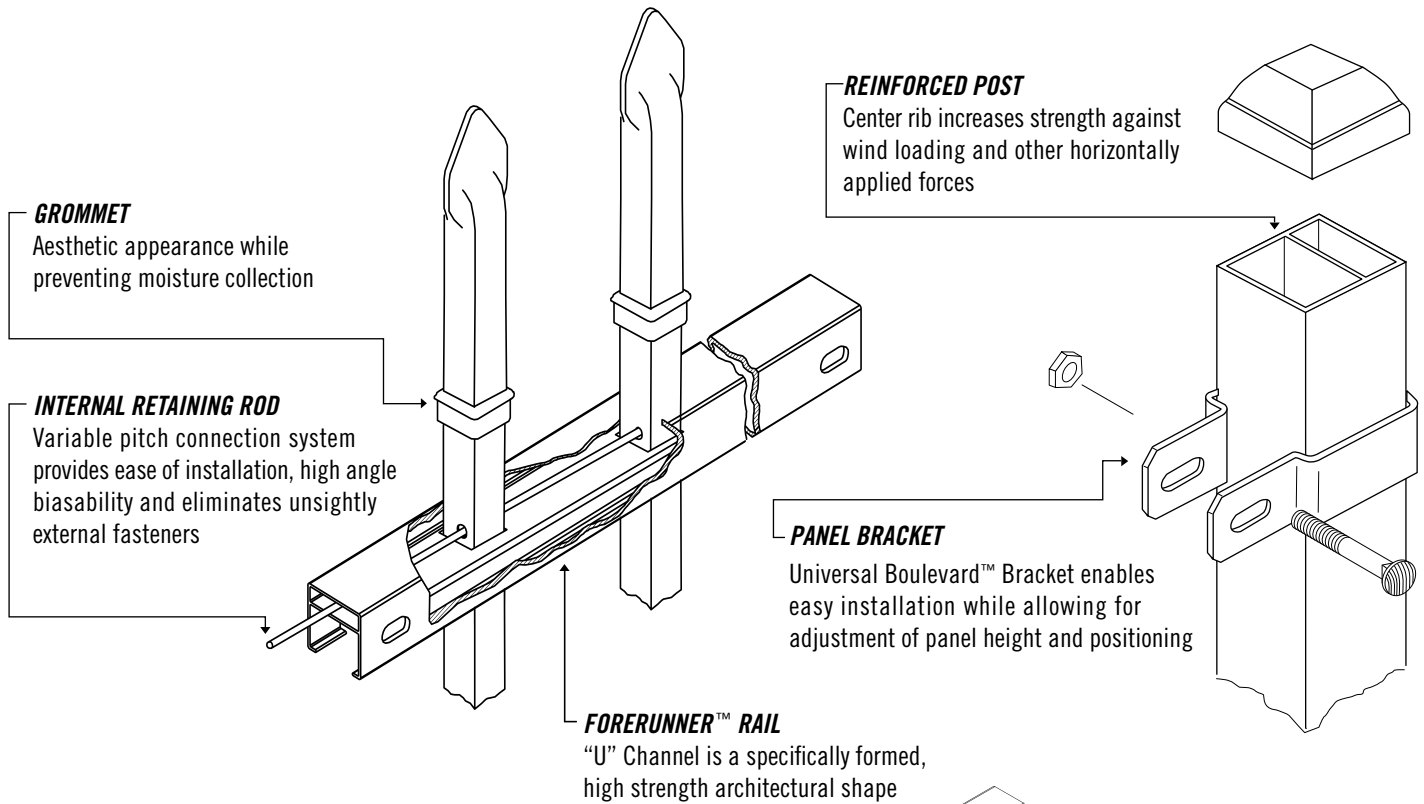

## ➤ INCREASED SECURITY

The ForeRunner Rail with internal retaining rod prevents the attachment from being compromised. Fasteners are not exposed

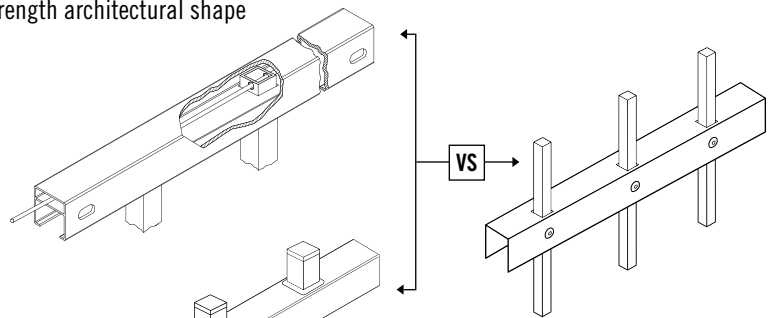

## ➤ AESTHETIC DETAILS

"Good Neighbor Design" rod follows ForeRunner centerline providing a clean and uninterrupted look, void of visible screws or rivets

## ➤ HIGH FUNCTIONALITY

Biasability at a minimum of 25% that requires no additional assembly

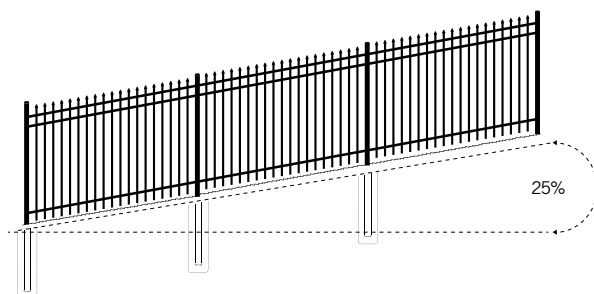

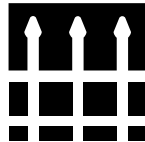

## **CLASSIC™**

Echelon Plus Classic style boasts *traditional extended pickets* with an arrow-shaped spear. These pointed pickets act as a *visual warning to potential intruders*.

- *3 Rail / 4 Rail options available*
- *Flush or Standard bottom options available*

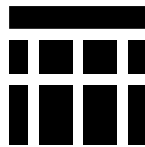

## **MAJESTIC™**

Echelon Plus Majestic has a *contemporary feel* that incorporates a *flush top rail* which produces a stately and streamlined appearance. This fence style *highlights the landscape* by blending with the surrounding architectural design.

- *3 Rail / 4 Rail options available*
- *Flush or Standard bottom options available*

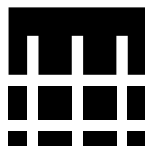

## **GENESIS™**

Echelon Plus Genesis has *sleek lines* of unaltered square pickets that are *reminiscent of solid vertical bar wrought iron*. The extended flat-topped tips can also be accented with decorative finials to enhance the fence design.

- *3 Rail / 4 Rail options available*
- *Flush or Standard bottom options available*



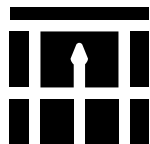

**CONQUEROR™**

Echelon Plus Conqueror marries *the best of classic style* with modern design. The spear tipped tops mingle below the *clean line of a straight rail*.

- *3 Rail / 4 Rail options available*
- *Flush or Standard bottom options available*

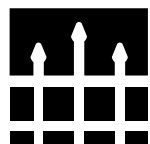

**WARRIOR™**

Echelon Plus Warrior adds *complexity and elegance* with *alternating picket heights*, bringing a higher level of sophistication to any fence system.

- *3 Rail / 4 Rail options available*
- *Flush or Standard bottom options available*

**ADORNMENTS**



QUAD FLARE



TRIAD



ROYALTY



RING

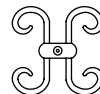

BUTTERFLY  
SCROLL



FLORENTINE  
SCROLL



BALL CAP

**COLORS**



BLACK



BRONZE



WHITE

## PUPPY PANELS

In many cases, particularly in relation to **safety or containment of small pets**, a narrower space between pickets may be necessary. Echelon Plus Puppy Panels **reduce the space between pickets** to less than 2" up to a height of 2' above ground.

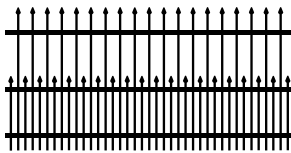

**CLASSIC™**

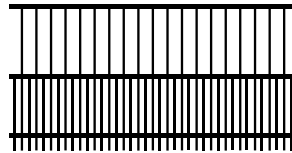

**MAJESTIC™**

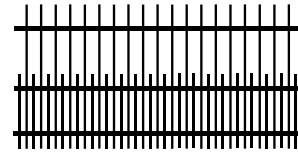

**GENESIS™**



### **POWDER COATED SUPERIOR FINISH**

Echelon features a state of the art polyester powder coating system that provides a durable and scratch resistant finish. This eco-friendly process provides years of long-lasting durability and maintenance-free ownership.



### **LIFETIME LIMITED WARRANTY**

The Echelon families of aluminum fencing products are manufactured from superior quality materials by skilled craftsmen with the highest standards of workmanship in the industry. Ameristar is confident in offering Echelon with a limited lifetime warranty, backed by over 30 years of demonstrated excellence in manufacturing of ornamental fence.



### **DOMESTIC MANUFACTURING**

Ameristar is committed to providing products that are manufactured in the USA. We have made significant investments in technology, process improvement, and employee training in an effort to secure American jobs and combat inferior import products.

## GATE SYSTEMS

Echelon Plus gate options vary from swing gates for pedestrian or vehicle entry to sliding entry gates for high functioning points of entry. Each of these gate systems are individually constructed with the highest level of craftsmanship to provide project specific performance.



# WHY CHOOSE AMERISTAR?

## ➤ **KNOWLEDGE & EXPERIENCE**

Ameristar was chartered 30 years ago in response to the demand by consumers and specifiers for specialty fence products. Ameristar offers an aesthetically pleasing product that is both high in quality and affordability. This has been achieved by maximizing high-volume productivity, increasing product design strength, and promoting simplistic installation.

## ➤ **PROVEN CAPABILITY**

Ameristar's integrated in-house process and extensive raw material inventory results in much improved productivity and availability compared to the competition. By having a vast finished goods inventory, Ameristar is capable of delivering finished products faster than competitors who sublet the majority of their operations.

## ➤ **INDUSTRY LEADERSHIP**

Over the years Ameristar has continually raised the bar across the board in the manufacturing of high quality, innovative fencing products. Our demonstrated commitment to upholding higher values translates into superior products that go far beyond merely meeting minimum industry standards.



Ameristar's world headquarters, manufacturing & coil processing facilities in Tulsa, Oklahoma, USA.

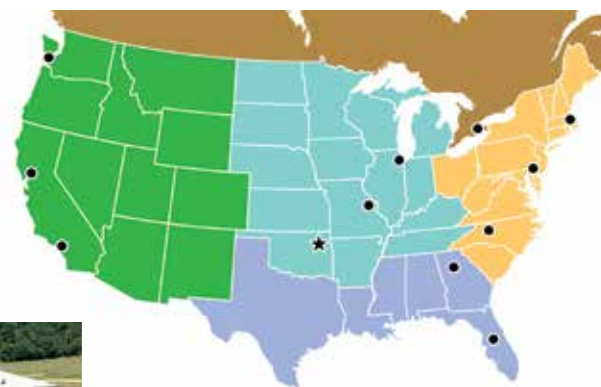

### LEGEND

- ★ Ameristar Headquarters
- Sales & Service Centers

Part #9729 | Revised 02/2014



[AMERISTARFENCE.COM](http://AMERISTARFENCE.COM) | 888-333-3422

ASSA ABLOY, the global leader in door opening solutions

**AMERISTAR**<sup>®</sup>  
**ASSA ABLOY**